

Article number: 07120051001

Description: Universal joint single 0.120.051.001
S=201 X= Bore with keyway

Measures

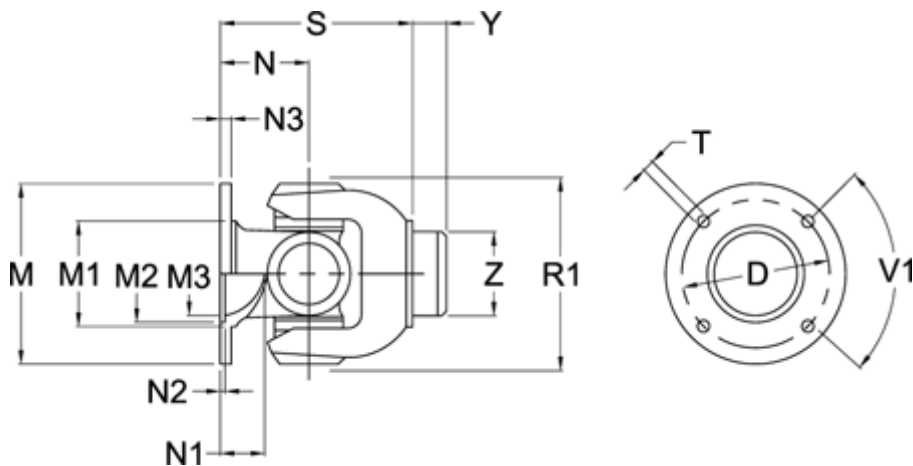

D	= 196 +0,1	N2	= 5 +0,5	Z = 98.25
Flange diameter M	= 225	N3	= 15	
M1	= 160	Number og Flangeholes	= 8	
M2	= 140	R1	= 178	
M3	= 130	S min	= 201	
Max. Bending Angle degrees	= 30	T	= 16 B12	
N	= 96	V1 degrees	= 45	
N1	= 32	Y	= 30	